



## About the BLSDH

The BLSDH is a linear architectural luminaire, crafted to seamlessly integrate into a variety of environments. Its modular design allows for effortless linking with other BLSDH fixtures, creating a continuous, elegant lighting effect that enhances the aesthetics of any space. This versatile fixture can be mounted surface-mounted, suspended, or pen dant-style, offering flexible installation options to suit diverse architectural needs. Ideal for applications such as offices, retail spaces, and educational institutions, the BLSDH provides a refined, professional light source that combines form and function to elevate any interior design.

## Specifications

Supported Voltage	120-277V, 347V, 120-347V
Available Lengths	6 inch increments up to 10ft
CCT	2700K, 3000K, 3500K, 4000K, 5000K, 6500K
CRI	80+ standard, 90+ and 95+ available
Lumens	up to 2500lm/ft
Dimming	0-10V Standard
Mounting	V hangers, aircraft cables, pendant mount
Lifetime	L70 of 99,000+ hours, L90 of 30,000+ hours

## Approvals

- ETL Listed
- Made with UL Listed components

## Ordering Information

Fill in the fields below with your product selections. If you need help with this section, [contact your local sales professional](#).

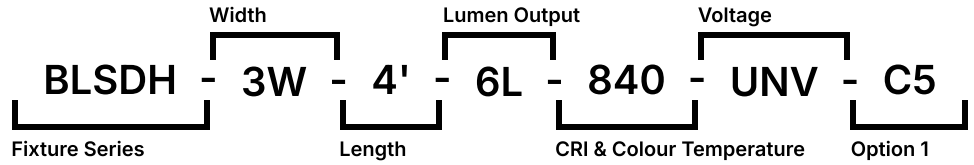

1	2	3	4	5	6	7
B LSDH						

Series	Size	Length	Lumen Output/ft	CRI	CCT	Voltage			
B LSDH	3W 3"	1'	1 FT	0.25	250 lm	8 80 CRI	27 2700K	UNV	120-277V
	4W 4"	2'	2 FT	0.50	500 lm	9 90+ CRI	30 3000K	347	347V
	6W 6"	3'	3 FT	0.75	750 lm	1 95+ CRI	35 3500K	UN3	120-347V
		4'	4 FT	1	1000 lm		40 4000K		
		5'	5 FT	1.25	1250 lm		50 5000K		
		6'	6 FT	1.5	1500 lm		65 6500K		
		7'	7 FT	1.75	1750 lm				
		8'	8 FT	2	2000 lm				
		9'	9 FT	2.25	2250 lm				
		10'	10 FT	2.5	2500 lm				

## Options

<p><b>Lenses</b></p> <ul style="list-style-type: none"> <li>L18 Frosted Lens (standard)</li> <li>L83 Bat Wing Optics</li> </ul> <p><b>Dimming</b></p> <ul style="list-style-type: none"> <li>B11 0-10V Dimming Leads</li> <li>B12 Line Voltage Dimming</li> <li>B27 Dim-to-off Driver</li> <li>B** Other Options Available*</li> </ul> <p><b>Controls</b></p> <ul style="list-style-type: none"> <li>WC10 Encelium Wireless Controls</li> <li>WC18 NX Wireless Controls</li> <li>WC19 Avi-on Wireless Controls</li> <li>WC22 JDRF Wireless Controls</li> <li>WC** Other Options Available*</li> </ul>	<p><b>Motion Sensors</b></p> <ul style="list-style-type: none"> <li>W26 Photocell Motion Sensor</li> <li>W57 Dimming Motion Sensor (dims to 50% when unoccupied)</li> <li>W53* On/Off</li> <li>W8* High/Low</li> <li>WX16 Microwave Dimmable Sensor</li> <li>W** Other Options Available*</li> </ul> <p><b>Emergency Driver</b></p> <ul style="list-style-type: none"> <li>B17 UL924 10W Battery Back-up</li> <li>F8 UL924 Emergency Relay</li> </ul> <p><b>Finish</b></p> <ul style="list-style-type: none"> <li>BLANK Standard Gloss White</li> <li>C5 Matte Black</li> <li>CUSTOM* Custom Colour Choice</li> </ul> <p><b>Packaging</b></p> <ul style="list-style-type: none"> <li>BLANK Individually Boxed on Pallets</li> <li>P0 Bulk Packaging</li> <li>P** Other Options Available*</li> </ul>	<p><b>Mounting</b></p> <ul style="list-style-type: none"> <li>M1 V-Hangers</li> <li>M2xx V-Hanger with Aircraft Loop Cables</li> <li>M3xx Y-Toggle Aircraft Cables</li> <li>M24 Single Pendant Mount(3/4 Hub)</li> <li>M36 Knock-outs on both ends</li> <li>M62xx Aircraft Loop Kits w/ Side Exit Cable Grippers</li> <li>M** Other Options Available*</li> </ul> <p><b>Canopy</b></p> <ul style="list-style-type: none"> <li>M35xx White canopy kits for T-bar or j-box mounting</li> <li>M61xx Black canopy kits for j-box mounting</li> </ul> <p><b>Modular Wiring</b></p> <ul style="list-style-type: none"> <li>W27XYZC Modular Power Cable</li> <li>W22XY Molex Row Mounting Wiring</li> </ul> <p><b>Warranty</b></p> <ul style="list-style-type: none"> <li>CL7 10-Year Comprehensive Warranty Upgrade</li> </ul>
---	--	--

## Documentation and Resources

All files and resources are available on our website for download. Files and resources are also embedded as links in this document, listed below. Additional files may be available upon request.





Please contact your local sales agent [here](#) or contact [sales@bjtake.com](mailto:sales@bjtake.com) for more information.

 [BLSDH Specification Sheet, 2025](#)

 [BLSDH-4'-5L-840-L18.ies](#)

## Certifications and Listings

Certifications that apply to this fixture and its possible configurations are listed here. More information available upon request.

Icon	Description
	Wireless Controls Available
	ETL Listed
	90 and 95+ CRI Options Available
	120-347V(UN3) Available

## Usage Applications

This fixture can be used in a variety of applications, and is ideal for the following:

Usage Application
Offices
Retail Stores
Schools

## Warranty Statement

BJ Take products are tested and/or inspected prior to being packaged for shipment and are guaranteed from the day the product is shipped for a period of ten-year LED chip warranty and a five-year comprehensive component warranty. This can be upgraded to a ten-year comprehensive warranty on request.

# BLSDH

## BLSDH 2' Side

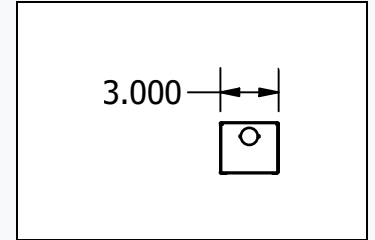
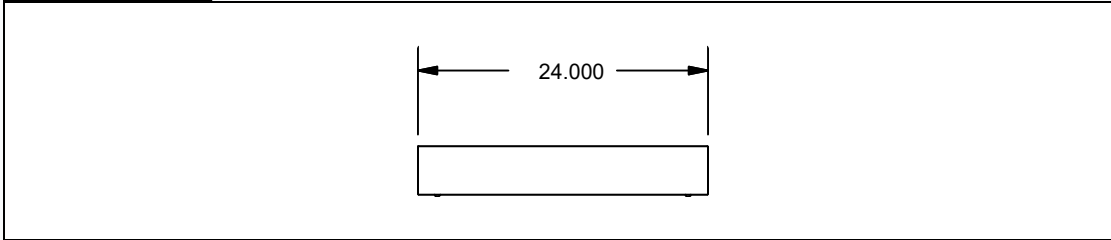

## BLSDH 4' Side

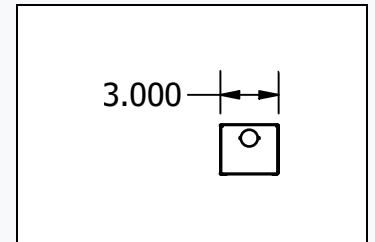
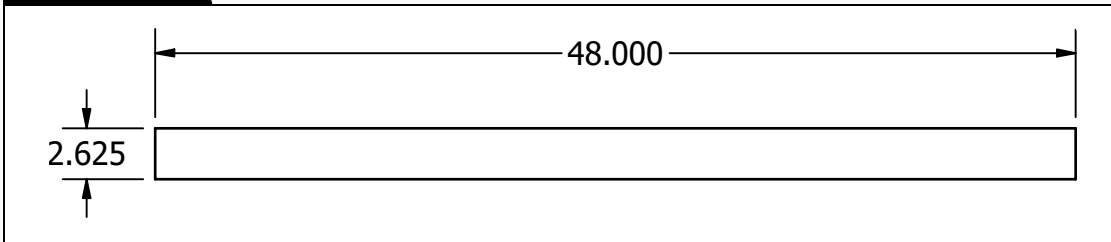

## BLSDH 8' Side

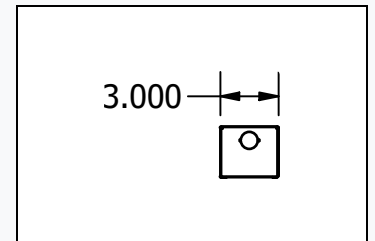
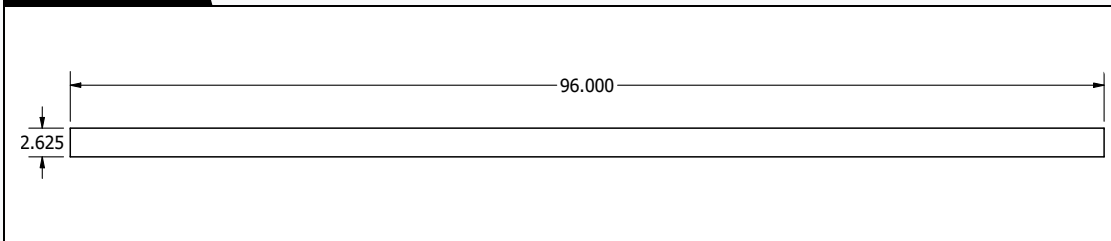

## BLSDH 10' Side

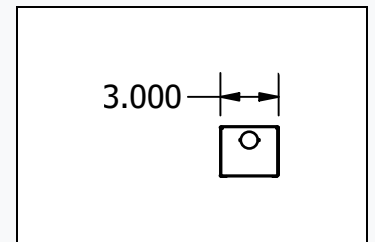
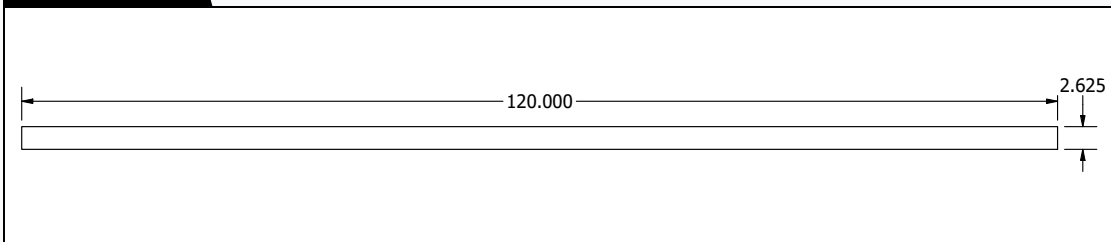

## Corner Segment

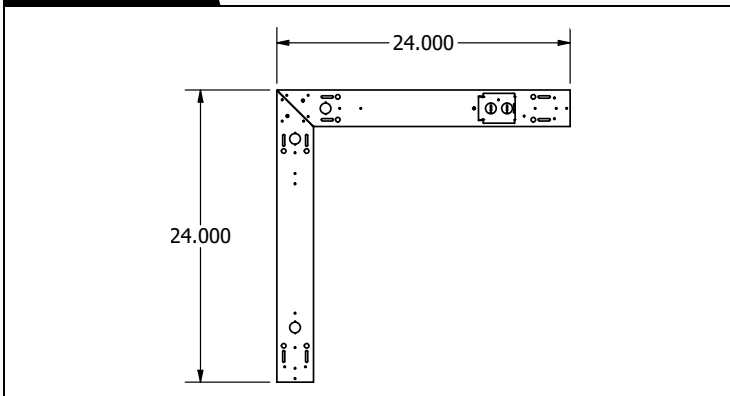

\* Drawings aren't to scale  
\* Standard tolerances apply  
\* Specifications may change without notice



# BLSDH

BLSDH-4'-5L-840-L18

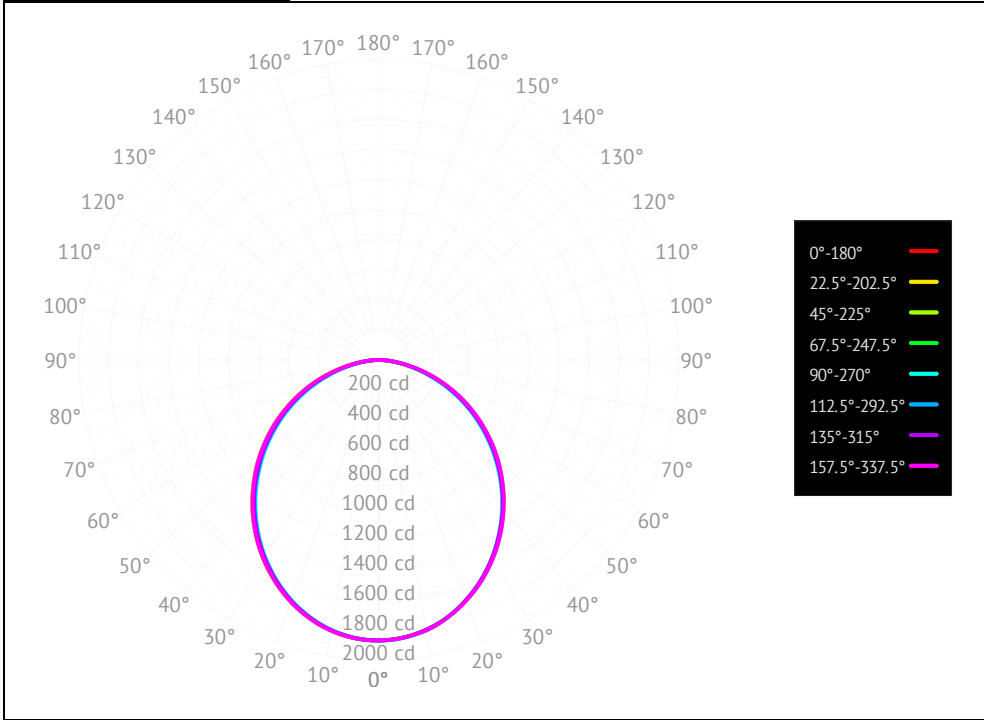

Cone of Light

Mtg Height	Light Level	Beam Diameter
6.0 ft	51.9 fc	16.5 ft
8.0 ft	29.2 fc	22.0 ft
10.0 ft	18.7 fc	27.4 ft
12.0 ft	13.0 fc	32.9 ft
14.0 ft	9.5 fc	38.4 ft
16.0 ft	7.3 fc	43.9 ft

\* Drawings aren't to scale

\* Standard tolerances apply

\* Specifications may change without notice

## Modular Wiring

The BLSDH has options for modular wiring.  
Below you will find the diagrams for these wiring options, and the relevant option codes necessary for ordering them.

### W22XY - Molex Row Mounting Wiring

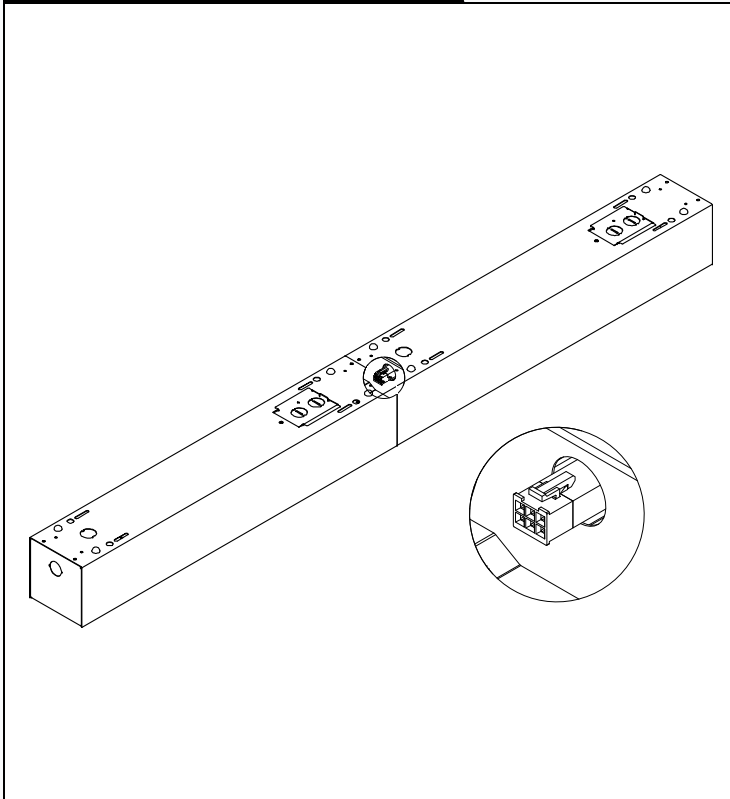

### W27XYZC - Modular Power Cable

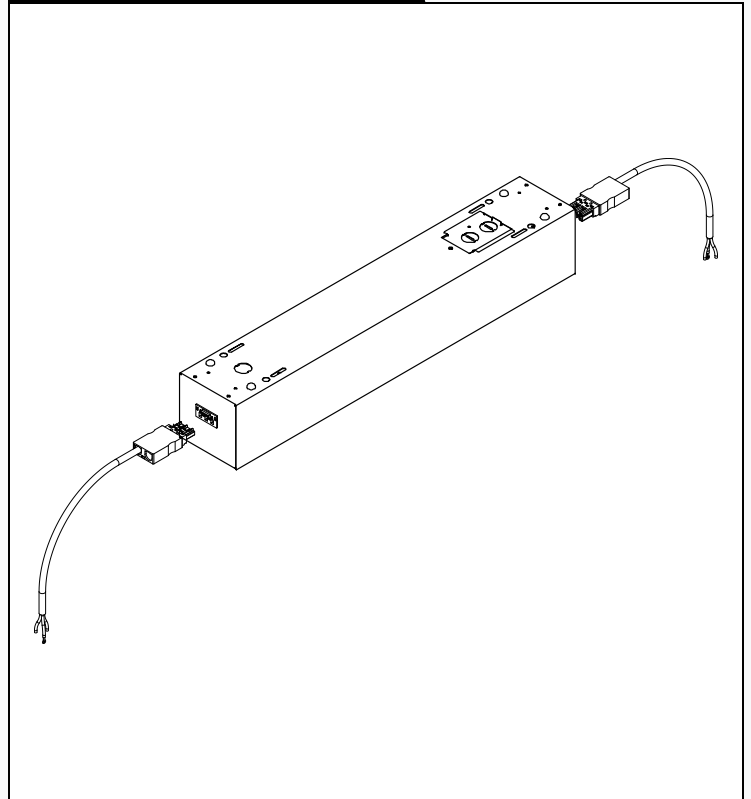

### W22XY - Molex Row Mounting Wiring

X - Style	Y - Poles	Through-Wiring
E - End	3 - 3 Pole	Blank - None
.	4 - 4 Pole	(RowA) - Alternating Circuit A
.	5 - 5 Pole	(RowB) - Alternating Circuit B
.	6 - 6 Pole	.

### W27XYZC - Modular Power Cable

X - Style	Y - Poles	Z - Wiring	C - Colour
S - Side	3 - 3 Pole	Blank - Standard	Blank - White
E - End	4 - 4 Pole	E - End of Row	B - Black
T - Top	5 - 5 Pole	.	G - Grey
.	6 - 6 Pole	.	.

# BLSDH

## Gallery Information

Below you will find images of relevant products and configurations for the BLSDH.

